

Electronic controller for snow- and ice-melting on roof & gutters

PRODUCT OVERVIEW

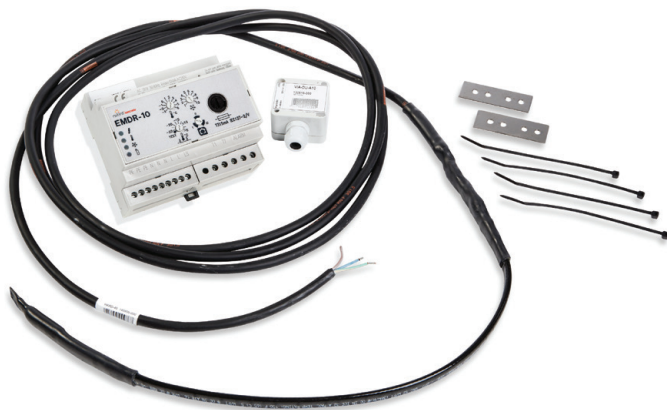

The nVent RAYCHEM EMDR-10 controller is designed for operation with the nVent RAYCHEM heating cables for roof & gutters.

Depending on outdoor temperature and moisture in the gutter, the heating cable will only be switched on if necessary to ensure a correct drain of the melting water.

FEATURES

- Easy set-up and programming of the unit
- Operates heating cables by temperature and moisture monitoring
- 2 sensors (ambient and moisture sensor)
- Saves up to 80% energy; using energy savings modes based on Proportional Ambient Sensing Control (PASC) algorithm for enhanced energy savings
- Max. switching current 10 A (otherwise switch via power contactor)
- Alarm relay with change over contact to signal unit or sensor problems
- DIN Rail mountable in panels

GENERAL

Area of use: Non-hazardous locations; for nVent RAYCHEM heating cables.

TECHNICAL DATA

Control Unit

Supply voltage	230 VAC, $\pm 10\%$, 50Hz
Power consumption	max. 4 VA
Max. switching capacity	I_{max} 10(4)A / 230 VAC, SPST, potential 230 VAC
Temperature set points	-3°C to $+6^{\circ}\text{C}$ (factory setting $+2^{\circ}\text{C}$)
Lower limit temperature range	-25°C to -5°C (factory setting -15°C) and test
Operating differential	± 0.5 K
Measuring accuracy	± 1.5 K
Moisture adjustment range	1 (max. sensitivity) to 10 (min. sensitivity) (factory setting 5)
Post heating time	60 minutes (only in temperature range $< +1,5^{\circ}\text{C}$) energy saving selectable
Alarm relay	I_{max} 2(1)A / 230 VAC, SPDT, potential-free
Moisture sensor (output)	230 VAC with fuse 5 x 20mm T 315mA (included) according to IEC127-2/V

TECHNICAL DATA

Mounting	DIN rail according to DIN EN 50022-35
Low voltage directive	EN 60730 EMC EN 50081-1 (emission) and EN 50082-1 (immunity)
Terminals	2.5 mm ² (stranded conductors), 4 mm ² (solid conductors)
Protection class	II (panel mounted)

Enclosure

Ambient temperature range*	0°C to +40°C
Ingress protection	IP20
Housing material	Noryl (self-extinguishing according to UL 94 V-0)
Dimensions	106 x 90 x 58 mm

* Continuous operation must be assured and the device must be protected from the penetration of moisture.

AMBIENT TEMPERATURE SENSOR (VIA-DU-A10)

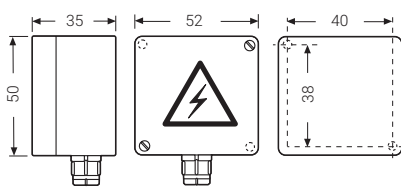

PG9 (Dimensions in mm)

Sensor Type	PTC
Ingress protection	IP54
Terminals	max. 2.5 mm ²
Sensor cable	2 mm ² x 1.5 mm ² max. 100 m (not included)
Exposure temperature	-30°C to +80°C
Mounting	Wall mounting

MOISTURE SENSOR (HARD-45)

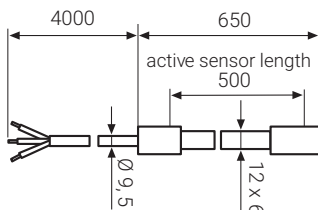

(Dimensions in mm)



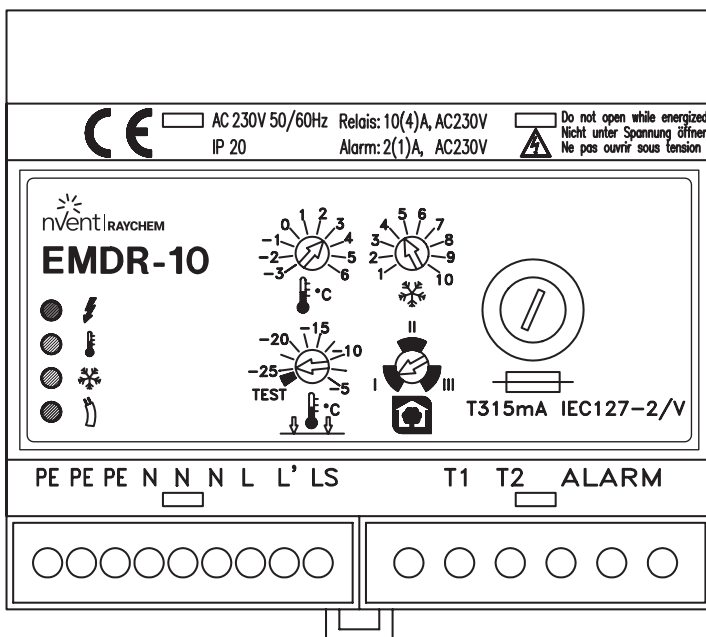

Sensor Type	PTC
Arrangement	0.5 m to 0.8 m flat cable
Power consumption	9 W to 18 W
Ambient temperature range	-30°C to +65°C continuous
Supply voltage	230 VAC, ±10%
Connection cable	3 x 1.5 mm ² , 4 m pre-assembled extendable to max. 100 m at 3 x 1.5 mm ²

MODULE LAYOUT



Display Elements

The LEDs indicate following operating conditions:

-  **LED green**
Device in operation (mains voltage).
-  **LED yellow**
Temperature setpoint
Adjusted air temperature threshold fallen below.
LED flashes in case of fault at the air temperature sensor (break or short circuit).
-  **LED yellow**
Moisture sensitivity
Adjusted moisture threshold exceeded.
LED flashes in case of fault at the moisture sensor (break) or fuse blown.
-  **LED red**
Heating cable energized.

DIMENSIONS

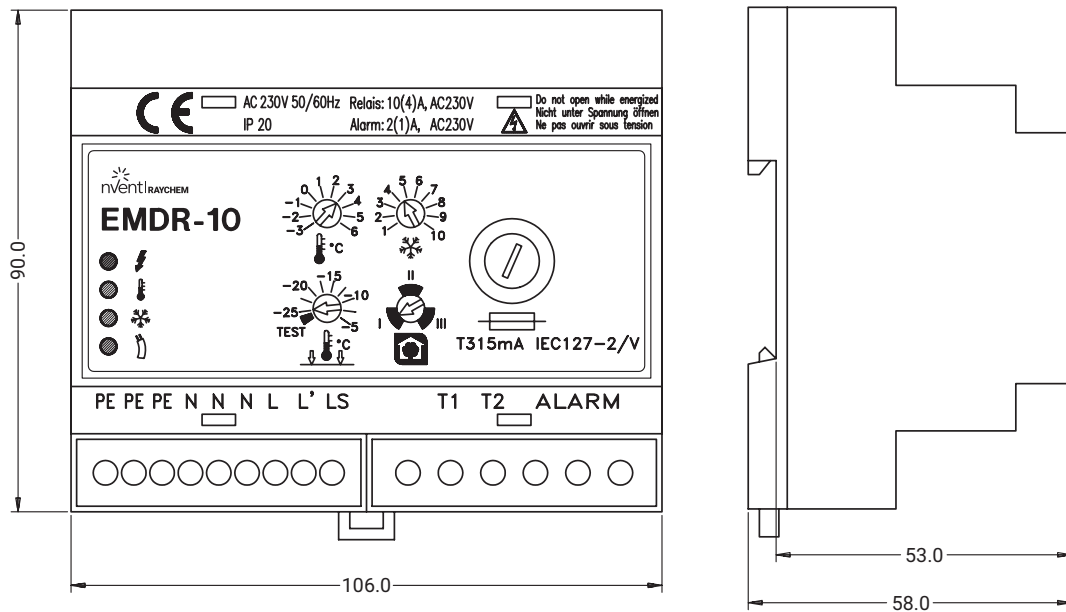

ELECTRICAL SCHEME

- The length of the heating cable determines the number and size of the circuit breakers.
- The use of a RCD (30 mA) is required by the manufacturer.
- Local standards for electrical connection must be observed.
- The device may only be connected up by an authorized electrician.
- Use C-characteristic circuit breaker!

Maximum heating cable length for -10°C start-up temperature at 230 VAC

Heating cable	GM-2X / GM2-XT	Frostop-Black
6 A (directly connected)	25 m	30 m
10 A (directly connected)	40 m	50 m
13 A (with contactor)	50 m	65 m
16 A (with contactor)	60 m	80 m
20 A (with contactor)	80 m	-

EMDR-10 WITH DIRECTLY CONNECTED HEATING CABLE

Attention: max. heating cable length 40 m, circuit breaker max. 10A (C-characteristic)

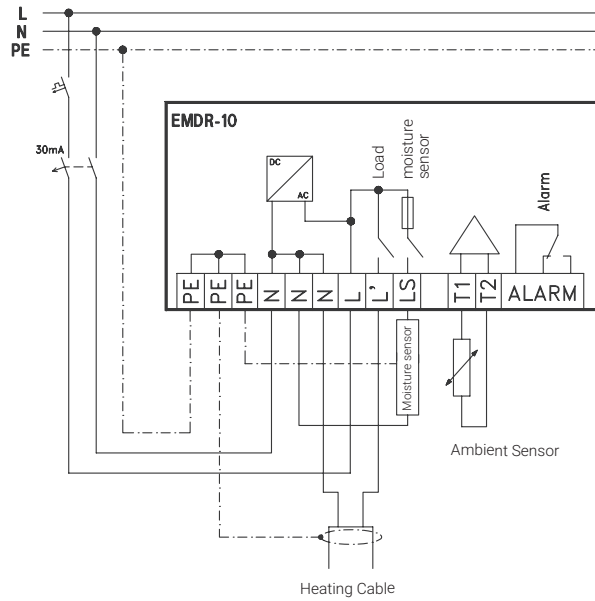

EMDR-10 WITH CONTACTOR

Attention: circuit breaker for EMDR-10 max. 10A

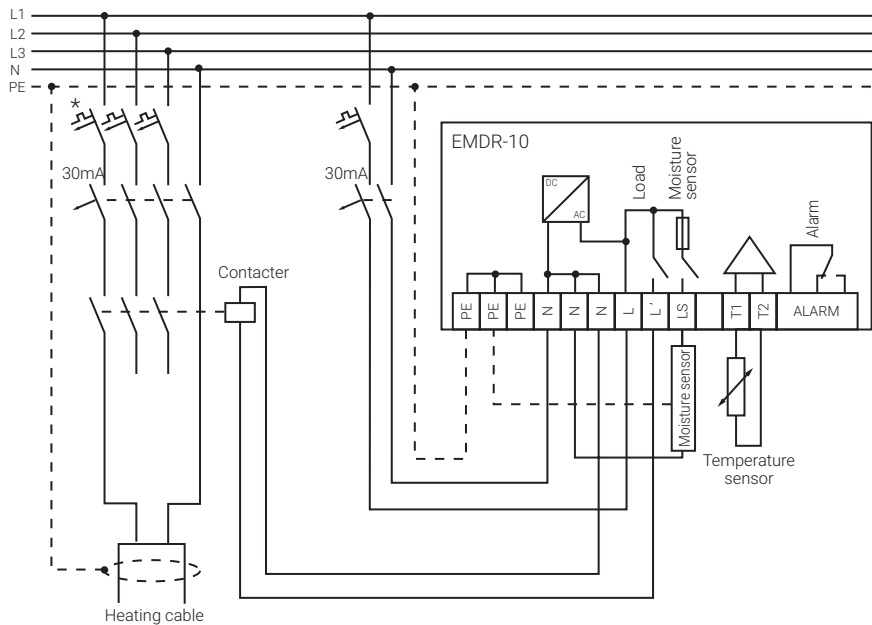

APPROVALS

Approvals	CE, ROHS, WEEE
Electromagnetic Compatibility (EMC)	EN 61000-6-1: 2007; EN 61000-6-3:2007 + A1:2011

ORDERING DETAILS

Catalog number	EMDR-10
Part number	449554-000
Weight	350 g
In package	Control unit, Din-rail, 1 ambient sensor VIA-DU-A10, 1 moisture sensor HARD-45

Europe, Middle East, Africa

Tel +32.16.213.511
Fax +32.16.213.603
info@nVent.com

Asia Pacific

Tel +86.21.2412.1688
Fax +86.21.5426.3167
info@nVent.com



Our powerful portfolio of brands:

CADDY ERICO HOFFMAN RAYCHEM SCHROFF TRACER