

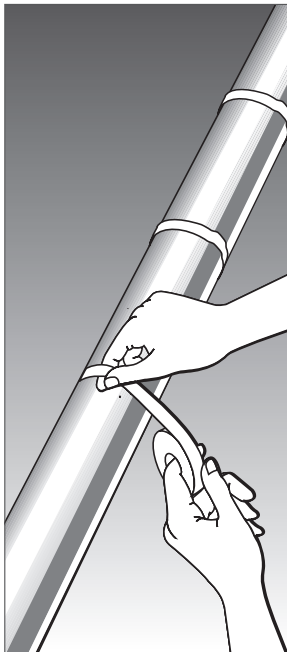

RAYCHEM

Commercial Heat-Tracing

Installation and Maintenance Manual
Self-Regulating Heating Cable Systems



1	General information	3
2	Product data	4
3	Heating cable selection	10
4	Heating cable storage	10
5	Product checks	11
6	Components installation	15
7	Controls, thermal insulation and marking	16
8	Power supply and electrical connection	18
9	Heating cable testing	19
10	Operation, maintenance and pipe repairs	20
11	Heating cable damage	20

1 GENERAL INFORMATION

Use of the manual

The Installation and Maintenance manual is for nVent's Raychem self-regulating heating cable systems on thermally insulated pipes. For gutters and downpipes consult the technical handbook.

For self-regulating ground or surface snow melting consult the technical handbook.

For self-regulating floor heating consult the handbook for comfortable warm floors.

For information regarding other applications contact your nVent representative.

Self-Regulating Cables

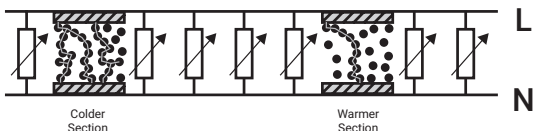

- ▶ Power output varies with temperature.
- ▶ As pipe temperature increases, power output decreases.
- ▶ At high temperatures, the polymer expands, reducing the number of the conductive paths, and thus reducing current flow.
- ▶ At low temperatures, there are many conductive paths, allowing current to flow between the conductors.

Important

For the nVent warranty to apply, the instructions that are included in this manual and product packages must be followed. The installation must be compatible with local requirements applicable to electric heat-tracing systems.

2 PRODUCT DATA

Cable type	HWAT-L	HWAT-M	
	Hot water temperature maintenance		
Nominal voltage	230 VAC	230 VAC	
Nominal power output (*on insulated metal pipes)	7 W/m at 45°C	9 W/m at 55°C	
C-type circuit-breaker according to selected kit	max. 20 A	max. 20 A	
Max. circuit length	180 m 20 A	100 m 20 A	
Min. bending radius	10 mm	10 mm	
Max. continuous exposure temperature	65°C	65°C	
Max. exposure temperature (power-on condition – 800 h. cumulative)	85°C	85°C	
Max. dimensions in mm (W x H)	13.8 x 6.8	13.7 x 7.6	
Weight	0.12 kg/m	0.12 kg/m	
Approvals/Certification	BS / ÖVE / VDE / SEV / CSTB / SVGW / EAC / UKrSEPRO		
Control units	HWAT-T55 HWAT-ECO SBS-xx-Hx-ECO panels ACS-30	HWAT-ECO SBS-xx-Hx-ECO panels ACS-30	
Connection system			
Junction box	–	–	
Connection and end seal	RayClic	RayClic	
Support bracket	Included in the kit	Included in the kit	

Warning

As with any electrical equipment or wiring installation operating at line voltages, heating cable and component damage or incorrect installation that allows the penetration of moisture or contamination can lead to electrical tracking, arcing and potential fire hazard.

	HWAT-R	FS-C10-2X
		Pipe Freeze Protection for LPHW services
	230 VAC	230 VAC
	12 W/m at 70°C	10 W/m at 5°C
	max. 20 A	max. 25 A
	100 m 20 A	180 m 20 A
	10 mm	10 mm
	80°C	90°C
	90°C	90°C
	16.1 x 6.7	16 x 6.8
	0.14 kg/m	0.14 kg/m
	HWAT-ECO SBS-xx-Hx-ECO panels ACS-30	RAYSTAT V5 ELEXANT 450c RAYSTAT-CONTROL-11-DIN* SBS-FP-xx panels AT-TS-13* AT-TS-14* ACS-30 *maximum circuit of 150m
	–	JB16-02
	RayClic	CE20-01
	Included in the kit	JB-SB-08

**Do not connect heating cable conductors together as this will result in a short circuit.
Any unconnected heating cable end must be sealed with a nVent approved end seal.**

Cable type	10XL2-ZH	15XL2-ZH	
Application	Pipe Freeze Protection	Pipe Freeze Protection	
Nominal voltage	230 Vac	230 Vac	
Nominal power output	10W/m @ 5°C.	15W/m @ 5°C.	
C-Type circuit breaker size	max. 20A	max. 20A	
Max circuit length	238m	188m	
Minimum bending radius	10 mm	10 mm	
Max. continuous exposure temperature	65°C	65°C	
Max exposure temperature (power off)	85°C	85°C	
Dimensions	13.7 x 6.2 mm	13.7 x 6.2 mm	
Weight	0.13kg/m	0.13kg/m	
Approvals	VDE/CSTB (IEC62395)	VDE/CSTB (IEC62395)	
Control Units	RAYSTAT V5 ELEXANT 450c RAYSTAT-CONTROL-11-DIN* SBS-FP-xx panels AT-TS-13* AT-TS-14* ACS 30 *maximum circuit of 150m	RAYSTAT V5 ELEXANT 450c RAYSTAT-CONTROL-11-DIN* SBS-FP-xx panels AT-TS-13* AT-TS-14* ACS 30 *maximum circuit of 150m	
Connection system			
Connection kit	RayClic	RayClic	
Support Bracket	Included in Kit	Included in Kit	

Warning

As with any electrical equipment or wiring installation operating at line voltages, heating cable and component damage or incorrect installation that allows the penetration of moisture or contamination can lead to electrical tracking, arcing and potential fire hazard.

	26XL2-ZH	31XL2-ZH
	Pipe Freeze Protection	Pipe Freeze Protection / Temperature maintenance for greasy waste pipes
	230 Vac	230 Vac
	26W/m @ 5°C.	31W/m @ 5°C.
	max. 20A	max. 20A
	142m	114m
	10 mm	10 mm
	65°C	85°C
	85°C	90°C
	13.7 x 6.2 mm	13.7 x 6.2 mm
	0.13kg/m	0.13kg/m
	VDE/CSTB (IEC62395)	VDE/CSTB (IEC62395)
	RAYSTAT V5 ELEXANT 450c RAYSTAT-CONTROL-11-DIN* SBS-FP-xx panels AT-TS-13* AT-TS-14* ACS 30 *maximum circuit of 116m	RAYSTAT V5 ELEXANT 450c RAYSTAT-CONTROL-11-DIN* SBS-FP-xx panels AT-TS-13* AT-TS-14* ACS 30 *maximum circuit of 91m
	RayClic	RayClic
	Included in Kit	Included in Kit

**Do not connect heating cable conductors together as this will result in a short circuit.
Any unconnected heating cable end must be sealed with a nVent approved end seal.**

Cable type	FroStop-Black	GM-2X (T)	EM2-XR	EM2-R
Product/ Application	Frost protection of pipes / Ice and snow protection of gutters and downpipes	Ice and snow protection of gutters and downpipes	Ramp and accessway heating	Ramp and accessway heating
Nominal voltage	230 Vac	230 VAC	230 VAC	230 VAC
Nominal power output (on insulated metal pipes)	16 W/m at 5°C	36 W/m in ice and 18 W/m in air at 0°C	90 W/m at 0°C in concrete	80 W/m at 0°C in concrete
C-type circuit-breaker according to selected kit	max. 16 A	max. 20 A	max. 50 A	max. 32 A
Max. circuit length	80 m 16 A	80 m 20 A	85 m 50 A	75 m 32 A
Min. bending radius	10 mm	10 mm	50 mm	50 mm
Max. continuous exposure temperature	65°C	65°C	100°C	90°C
Max. exposure temperature (power-on condition – 800 h. cumulative)	65°C	85°C	110°C	90°C
Max. dimensions in mm (W x H)	12.5 x 5.3	13.7 x 6.2	18.9 x 9.5	11.8 x 4.5
Weight	0.13kg/m	0.13 kg/m	0.27 kg/m	0.13 kg/m
Approvals	VDE / Intertek Semko	VDE	CE	
Control units	EMDR-10 GM-TA RAYSTAT V5 ELEXANT 450c RAYSTAT-CONTROL-11-DIN* SBS-FP-xx panels AT-TS-13* AT-TS-14* ACS-30 *maximum circuit of 150m	EMDR-10 GM-TA RAYSTAT-M2 SBS-XX-EV panels ACS-30	VIA-DU-20 RAYSTAT-M2 SBS-XX-VV panels ACS-30	VIA-DU-20 RAYSTAT-M2 SBS-XX-VV panels ACS-30
Connection system				
Junction box	JB16-02	–	VIA-JB2	JB-82
Connection kit	CE20-01 CCE-06-CR	RayClic CCE-04-CT	VIA-CE1	CCE-04-CT
Support bracket	JB-SB-08	Included with RayClic	–	–

Warning

As with any electrical equipment or wiring installation operating at line voltages, heating cable and component damage or incorrect installation that allows the penetration of moisture or contamination can lead to electrical tracking, arcing and potential fire hazard.

	R-ETL-A	R-ETL-B	R-ETL-A-CR	R-ETL-B-CR
	Frost protection for pipes	Frost Protection for pipes	Frost Protection for pipes	Frost Protection for pipes
	230 VAC	230 VAC	230 VAC	230 VAC
	10 W/m at 5°C on pipe	16W/m at 5DegC on pipe.	10W/m at 5DegC on pipe.	16W/m at 5DegC on pipe.
	max. 10 A	max. 16A	max. 10A	max. 16A
	100 m 10 A	100 m 16A	100 m 10A	100 m 16A
	10 mm	10 mm	10 mm	10 mm
	65°C	65°C	65°C	65°C
	65°C	65°C	65°C	65°C
	8.5 x 5.8	8.5 x 5.8	8.5 x 5.8	8.5 x 5.8
	0.07 kg/m	0.07kg/m	0.07kg/m	0.07kg/m
	VDE / Intertek Semko / CSTB		VDE / CSTB	
	RAYSTAT V5 ELEXANT 450c RAYSTAT-CONTROL-11-DIN SBS-FP-xx panels AT-TS-13 AT-TS-14 SBS-R-FP panels	RAYSTAT V5 ELEXANT 450c RAYSTAT-CONTROL-11-DIN SBS-FP-xx panels AT-TS-13 AT-TS-14 SBS-R-FP panels	RAYSTAT V5 ELEXANT 450c RAYSTAT-CONTROL-11-DIN SBS-FP-xx panels AT-TS-13 AT-TS-14 SBS-R-FP panels	RAYSTAT V5 ELEXANT 450c RAYSTAT-CONTROL-11-DIN SBS-FP-xx panels AT-TS-13 AT-TS-14 SBS-R-FP panels
	JB16-02	JB16-02	JB16-02	JB16-02
	CE-ETL/T2Red U-ACC-PP-07 CE20-03	CE-ETL/T2Red CE20-03 U-ACC-PP-07	CE20-03 U-ACC-PP-07	CE20-03 U-ACC-PP-07
	JB-SB-08	JB-SB-08	JB-SB-08	JB-SB-08

**Do not connect heating cable conductors together as this will result in a short circuit.
Any unconnected heating cable end must be sealed with a nVent approved end seal.**

3 HEATING CABLE SELECTION

Check the design specification to make sure the proper heating cable is selected for each pipe or surface. Refer to nVent product literature or the TraceCalc Net Construction software to select the proper heating cable for each application.

Look-up Table: The following table shows which heating cables are suitable for use with specific applications.

Product/ Application	Frost Protection for Pipes	Flow Maintenance	Hot Water Temperature Maintenance	Ice/Snow Protection of Gutters	Ice/Snow Protection of Ground Surfaces
10XL2-ZH	✓				
15XL2-ZH	✓				
26XL2-ZH	✓				
31XL2-ZH	✓	✓			✓
FS-C10-2X	✓				
FroStop- Black	✓			✓	
HWAT-L			✓		
HWAT-M			✓		
HWAT-R			✓		
GM-2X (T)				✓	
EM2-XR					✓
EM2-R					✓
R-ETL-A-CR R-ETL-B-CR R-ETL-A R-ETL-B	✓				

4 HEATING CABLE STORAGE



- ⇒ Store in a dry and clean place.
- ⇒ Temperature range: -40°C to +60°C.
- ⇒ Protect any cable ends with an end seal.

5 PRODUCT CHECKS

5.1 Pre-installation checks

Check materials received:

- Review the heating cable design and compare the list of materials to the catalogue numbers of heating cables and electrical components received to confirm that proper materials are on site. The heating cable type is printed on its outer jacket.
- Temperature exposure must not exceed that specified in nVent' product literature. Exceeding these limits will impair product performance. Check that expected exposure is within these limits.
- Ensure that the heating cable voltage rating is suitable for the service voltage available.
- Do not energize cable when it is coiled or on the reel.
- Inspect heating cable and components for in-transit damage. An insulation resistance test (Section 9) on each reel is recommended.

Check piping to be traced:

- Ensure all pressure testing is complete and pipework has final paint coating.
- Walk the system and plan the routing of the heating cable on the pipe.
- Check pipework against specification drawing. If different consult design authority.
- Inspect piping for burrs, rough surfaces, sharp edges etc. which could damage the heating cable. Smooth off or cover with layers of glass cloth tape or aluminium foil.

5.2 Heating cable handling

Heating cable handling tips:

- Paint and pipe coatings must be dry to the touch before heating cable installation.
- When pulling the heating cable, **avoid:**
 - ⇨ sharp edges
 - ⇨ high tractive force
 - ⇨ kinking and crushing
 - ⇨ walking or driving over the cable
 - ⇨ moisture at cable interfaces

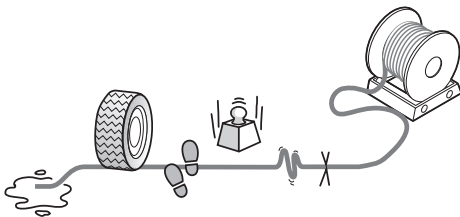

Heating cable pulling tips:

- Use a reel holder that pays out smoothly with little tension.
- Keep heating cable strung loosely but close to the pipe being traced to avoid interference with supports and equipment.
- Pay out designed length and mark (i.e. with fixing tape) on cable while still on reel.
- Leave the appropriate amount of heating cable at all power connection, splice, tee and end seal locations. (Refer to component installation instructions)
- ⇨ **Add additional heating cable to trace the fittings and supports or for spiralling as required by the design specifications, or consult nVent product literature for design.**
- Protect all heating cable ends from moisture, contamination and mechanical damage or other interference if left exposed before component installation.

5.3.1 Heating cable on pipe attachment recommendations

- The heating cable may be installed straight (spiralled or in multiple runs as required by the design specification, nVent product literature or TraceCalc software).
- ⇨ **Do not** use metal attachments, vinyl electrical tape or duct tape as heating cable damage may result.
- ⇨ Self-regulating technology allows for the multiple overlapping of the heating cable on to itself.

5.3.2 Heating cable, non-pipe fixing recommendations

- For snow and ice protection applications, the heating cable should be fixed in place using one of the nVent recommended fixing methods, including spacer rail or connection to a reinforcement grid.
- For gutter applications, the heater should be held in place within the gutter using recommended fixing clips as supplied by the manufacturer.
- For underfloor heating applications, the heater shall be installed using the fixing methods of the manufacture or installed in the T2Reflecta heat reflector product.

5.4 Straight tracing

- Straight trace the pipe unless the design calls for spiralling.
- On horizontal pipes, fix on lower quadrant (5 O'clock or 7 O'clock positioning on pipe) and not on bottom of pipe.
- Read the kit installation instructions and plan the component location before permanently attaching the cable to the pipe.
- Thermally insulate and weatherproof to specification.

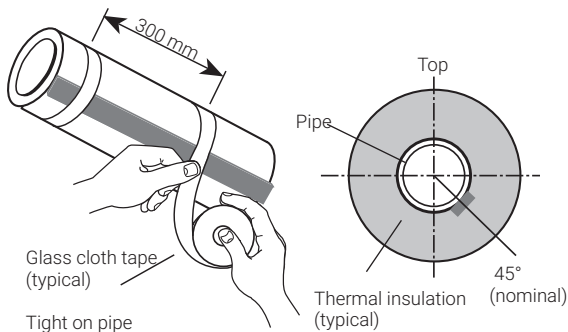

nVent attachment tapes:

- | | |
|---------|---|
| GT66 | Self-adhesive glass cloth tape General purpose tape. GS-54 Self-adhesive glass cloth tape for stainless-steel pipes. KBL-10 cable ties |
| ATE-180 | Aluminium fixing tape. Using only if required for the system design (Typically for temperature maintenance applications such as HWAT on plastic pipes). |

5.5 Cutting the heating cable

- ▶ Cut the heating cable to length after it is attached to the pipe. Before cutting it, confirm the tracing allowance as per Section 2.
- ▶ Raychem heating cable can be cut-to-length without affecting the heat output per metre.

5.6 Installation details

- ▶ Follow the recommendations for cutting and stripping heating cables; they are included in the component installation instructions.

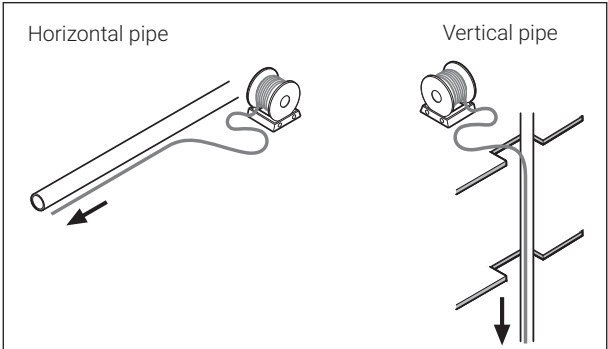

Cut the heating cable at right angles

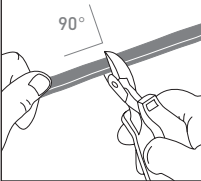

Smallest bending radius: 10 mm

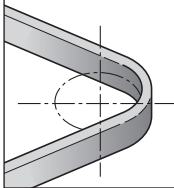

Run the cable over pipe suspensions

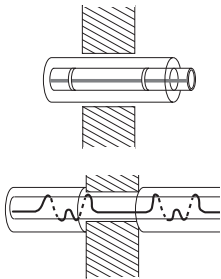
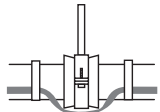

Wall/Floor transit

The thickness of thermal insulation must be continuous otherwise compensate by adding heating cable.

Do not clamp the cable

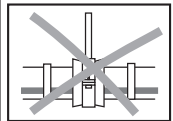

6 COMPONENTS INSTALLATION

General notes:

Select the required components from nVent product literature or use the TraceCalc Net Construction software. Raychem component kits (including power connections, splices and end seals) must be used to satisfy Standards and Approval Body requirements.

Installation instructions included in the kit must be followed, including those for preparation of the heating cable conductors for connections. Before assembly, use the guide given in the instructions to ensure that the kit is correct for the heating cable and environment.

⇒ Raychem self-regulating and power-limiting heating cables are parallel circuit design. Do not twist the conductors together as this will result in a short circuit.

6.1 Components required

- For the installation of all components refer to the relevant component installation instructions.
- Required for each heating cable run:
Power connection and end-seal.
- As required:
Splice
Tee-splice: RayClic or junction box, three connection kits and three insulation entry kits, depending on heater.
Accessories (pipe straps, fixing tape, support brackets, labels, etc)

6.2 Component installation hints

- Locate RayClic / junction boxes for easy access but not exposed to mechanical abuse.
- Position junction boxes so that power cable and heating cable entries do not point upwards.
- Fix lids in place where access not required.
- Confirm junction box stopping plugs are correct for application and fixed firmly in place.
- Route heating cable from RayClic / junction box to insulation entry so as to avoid possible mechanical damage.
- ⇒ **Do not** strain heating cable as it exits/enters RayClic / junction boxes and insulation entries.
- Ensure heating cable is fixed above pipe straps such as used for RayClic / junction box support brackets.
- Fix all low profile components (e.g. heatshrink end seals) in place.

7 THERMAL INSULATION AND MARKING

7.1 Pre-insulation checks

- Visually inspect the heating cable and components for correct installation and damage. (See Section 11 if damaged.)
- Insulation resistance (Megger) testing (as per Section 9) is recommended prior to covering the pipe with thermal insulation.

7.2 Thermostats and control systems

- In temperature-sensitive applications, thermostatic control may be necessary. Furthermore, for maximum energy efficiency, nVent requires the installation and use of an approved controller for the application.
- Follow the installation instructions supplied with the thermostat or control. Use the proper wiring diagram for the heating cable layout and control method desired.
- After switching on the heating cable, the cable ends must be warm after 5 to 10 minutes.

7.3 Insulation installation hints

- Correct temperature maintenance requires properly installed and dry thermal insulation.
- Thermally insulate and weatherproof to design specification.
- Check insulation type and thickness against the design specification.
- To minimize potential heating cable damage, insulate as soon as possible after tracing.
- Check that all pipework, including fittings, wall penetrations and other areas, have been completely insulated.
- Ensure that heating cable is not damaged during installation of cladding for example by drills, self-tapping screws and sharp edges of cladding.
- Check that all insulation entry kits are fitted correctly and sealed.
- Ensure that all areas where valve stems, support brackets etc. exit the insulation are appropriately insulated and sealed.

7.4 Marking

- ▶ Install “Electric Traced” signs along piping at suitable intervals (5 m intervals recommended) on alternate sides as a warning.
- ▶ Mark on outside of insulation the location of heating cable components.
- ▶ For outdoor de-icing and snow melting applications, the presence of heat-tracing shall be made evident by the posting of caution signs or marking where clearly visible.

8 ELECTRICAL PROTECTION

8.1 Overcurrent protection

Size circuit breakers according to the design specification or applicable nVent product literature. If devices other than those specifically identified are used, consult the nVent representative for the appropriate sizing information.

8.2 Residual current (earth fault) protection

nVent requires the use of a 30 mA residual current device to provide maximum safety and protection from fire. Ground fault protection is required in any installation. The metal braid covering the trace heater shall be connected to an earth terminal for electrical protection of the circuit.

9 HEATING CABLE TESTING

9.1 Recommendations

nVent recommends insulation resistance (Megger) test before installing heating cable; before installing thermal insulation; prior to initial start-up (disconnected from the controls).

9.2 Test method

After completing heating cable installation, the insulation resistance between the conductors and the braid should be checked using a 2.500 VDC megger tester. Minimum readings should be 100 Megohms regardless of the heating cable length. The installer should record the original values for each circuit on the installation record sheet (see page 21).

Measurement A

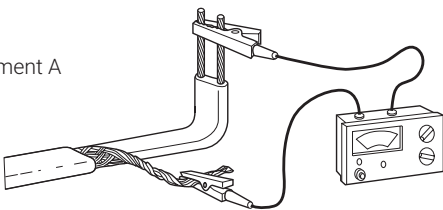

Measurement B

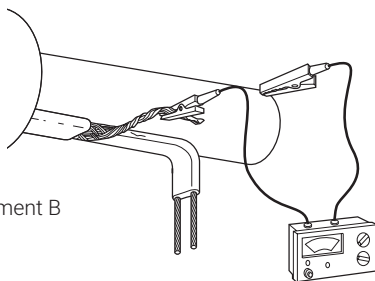

10 OPERATION, MAINTENANCE AND PIPE REPAIRS

10.1 Heating cable operation

- **Temperature exposure must not exceed that specified in nVent product literature. Exceeding those limitations will shorten the service life and may permanently damage the heating cable.**
- Pipe insulation must be complete and dry to maintain the correct temperature.

10.2 Inspection and maintenance

De-energise all power circuits before installation or servicing and maintenance.

- Visual inspection: Exposed heating cable and pipe insulation should be checked periodically to make sure that no physical damage has occurred.
- Function testing of electrical protection and temperature control systems should be carried out before the winter months each year. Temperature maintenance systems should be tested at least twice a year.
- The Periodic Inspection Record on the following pages should be filled out during maintenance of each circuit in your system.

10.3 Piping systems repair and maintenance

- Isolate heating cable circuit.
- Protect the heating cable from mechanical or thermal damage during pipe repair work.
- Check heating cable installation after pipe repairs and restore thermal insulation following the recommendations in Section 7. Check correct functioning of electrical protection systems.

11 HEATING CABLE DAMAGE

Heating cable damage

- **Do not repair damaged heating cable.**
Remove entire damaged section and splice in a new length using the appropriate Raychem splice kits.
- **Replace damaged heating cable at once.**
Damage allowing moisture and contamination to enter the heating cable may result in arcing earth faults and potential fire hazards.
- Heating cable exposed to fire or flame may cause further fire damage if powered.
Remove from service at once and replace before re-use.

INSPECTION AND MAINTENANCE RECORD SHEET

CIRCUIT NO.		MONTH: _____ YR: _____									
		MAINTENANCE CHECKS FOR:									
No signs of overheating, moisture, or corrosion, etc.	Confirm value										
	Date										
In connection systems Heating cable and cable glands tight Connection terminals tight Earth connection tight Insulation in good condition	Confirm value										
	Date										
Thermostats set properly and capillaries are protected	Confirm value										
	Date										

TROUBLESHOOTING GUIDE

Symptom	Probable causes
Circuit Breaker overcurrent protection trips or blows.	Electrical fault at: <ul style="list-style-type: none"> • damaged heating cable • faulty splices or tees • end seal • connection
	Circuit oversized
	Start-up below design temperature
	Defective electrical protection

Symptom	Probable causes
RCD trips	Earth fault at: <ul style="list-style-type: none"> • damaged heating cable • faulty splices or tees • end seal • connection
	<ul style="list-style-type: none"> • junction boxes • splices and tees • end seals
	High leakage currents due to a combination of excessive lengths of power cable and heating cable.
	Mains borne disturbances
	Defective RCD

Corrective action
Investigate and remedy (see note 1):
Resize or redesign within Technical Handbook Guidelines. (If larger protection is required, ensure supply cables are compatible).
design for lower start-up temperatures. reheat pipe from alternative heat source to within exposure temperatures given in Product Data. energize part of circuit followed by remainder (e.g. in sequence).
Replace

Corrective action
Investigate and remedy (see note 1):
Dry out and reseal or remake immediately. Perform insulation resistance test. (100 MΩ minimum)
Redesign
Redesign distribution, guidance is available from nVent.
Replace

Symptom	Probable causes
No power output	Loss of supply voltage due to: <ul style="list-style-type: none"> • overcurrent or residual current protection trip • loose terminals in junction box • loss of supply cable continuity (e.g., open • ircuitued from damage
	Control thermostat is connected in the normally open position
	High resistance connection at: <ul style="list-style-type: none"> • junction box terminals • splices and tees

Symptom	Probable causes
Low pipe temperature	Wet thermal insulation
	Design error
	Incorrect setting or operation of controls e.g., thermostats.
	Heating cable has been exposed to excessive temperature beyond rating.

Note:

Locate faults by the following steps:

- 1 Visually inspect the power connections, splices and end seals for correct installation.
- 2 Look for signs of damage at:
 - a) Valves, pumps, flanges and supports.
 - b) Areas where repairs or maintenance work has been carried out.
- 3 Look for crushed or damaged insulation and cladding along the pipe.

Corrective action
<p>Restore supply voltage</p> <ul style="list-style-type: none"> • following A and B (page 20) • re-tighten terminals <p>NB: If excessive heating has occurred due to high resistance, replace terminals or crimps</p> <ul style="list-style-type: none"> • locate damage and repair
Reconnect to normally closed position
<p>Locate and remedy by:</p> <ul style="list-style-type: none"> • re-tighten • repair <p>NB: If excessive heating has occurred due to high resistance, replace terminals or crimps</p>
Corrective action
Remove and replace with dry insulation of correct specification and ensure complete weatherproofing
<ul style="list-style-type: none"> • check with competent authority for design conditions • modify to meet nVent recommendations
Repair or reset to correct level of operation
Replace

4 If after 1, 2 and 3 above the fault has not been located, then either:

- a) Consult nVent for further assistance.
- b) Where local practices and conditions allow (e.g., non hazardous areas) isolate one section of heating cable from another by cutting in half and testing (e.g., Insulation Resistance) both halves until general area of damage is found.
Remove insulation and expose fault.

België/Belgique

Tel +32 16 21 35 02
Fax +32 16 21 36 04
salesbelux@nvent.com

Bulgaria

Tel +359 5686 6886
Fax +359 5686 6886
salesee@nvent.com

Česká Republika

Tel +420 606 069 618
czechinfo@nvent.com

Denmark

Tel +45 70 11 04 00
salesdk@nvent.com

Deutschland

Tel 0800 1818205
Fax 0800 1818204
salesde@nvent.com

España

Tel +34 911 59 30 60
Fax +34 900 98 32 64
ntm-sales-es@nvent.com

France

Tél 0800 906045
Fax 0800 906003
salesfr@nvent.com

Hrvatska

Tel +385 1 605 01 88
Fax +385 1 605 01 88
salesee@nvent.com

Italia

Tel +39 02 577 61 51
Fax +39 02 577 61 55 28
salesit@nvent.com

Lietuva/Latvija/Eesti

Tel +370 5 2136633
Fax +370 5 2330084
info.baltic@nvent.com

Magyarország

Tel +36 1 253 7617
Fax +36 1 253 7618
saleshu@nvent.com

Nederland

Tel 0800 0224978
Fax 0800 0224993
salesnl@nvent.com

Norge

Tel +47 66 81 79 90
salesno@nvent.com

Österreich

Tel 0800 29 74 10
Fax 0800 29 74 09
salesat@nvent.com

Polska

Tel +48 22 331 29 50
Fax +48 22 331 29 51
salespl@nvent.com

Republic of Kazakhstan

Tel +7 7122 32 09 68
Fax +7 7122 32 55 54
saleskz@nvent.com

Россия

Тел +7 495 926 18 85
Факс +7 495 926 18 86
salesru@nvent.com

Serbia and Montenegro

Tel +381 230 401 770
Fax +381 230 401 770
salesee@nvent.com

Schweiz/Suisse

Tel +41 (41) 766 30 80
Fax +41 (41) 766 30 81
infoBaar@nvent.com

Suomi

Puh 0800 11 67 99
salesfi@nvent.com

Sverige

Tel +46 31 335 58 00
salesse@nvent.com

Türkiye

Tel +90 560 977 6467
Fax +32 16 21 36 04
ntm-sales-tr@nvent.com

United Kingdom

Tel 0800 969 013
Fax 0800 968 624
salesthermalUK@nvent.com



nVent.com / RAYCHEM

©2020 nVent. All nVent marks and logos are owned or licensed by nVent Services GmbH or its affiliates. All other trademarks are the property of their respective owners. nVent reserves the right to change specifications without notice.

RAYCHEM-IM-CDE1547-HeatTracing-EN-2010

PCN 1244-022599